

Safety Non-contact Door Switch



SFN Series

For your safety, read and follow the considerations written in the instruction manual, other manuals and Autonics website.

The specifications, dimensions, etc. are subject to change without notice for product improvement. Some models may be discontinued without notice.

Features

- Vertical/Horizontal installation supported
- Available to install at back-forth, up-down, right-left moving door
- Connectable maximum 30 units to one controller
- Easy notification of operation status with an operation indicator (ON: green, OFF: red)

Safety Considerations

- Observe all 'Safety Considerations' for safe and proper operation to avoid hazards.
- ⚠ symbol indicates caution due to special circumstances in which hazards may occur.

⚠ Warning Failure to follow instructions may result in serious injury or death.

- 01. Fail-safe device must be installed when using the unit with machinery that may cause serious injury or substantial economic loss. (e.g. nuclear power control, medical equipment, ships, vehicles, railways, aircraft, combustion apparatus, safety equipment, crime/disaster prevention devices, etc.)**
Failure to follow this instruction may result in personal injury, economic loss or fire.
- 02. System manager means followings;**
 - a personnel who is fully aware of installation, setting, operation, and maintenance of the product
 - a personnel who well observes standard/regulation/statute on the product by type of machine the product installed in and nation/region the product used in**Machine user means a personnel who is appropriately trained about using machine by the system manager, so that machine user can operate the machine correctly. System manager has duty to train the machine user about operation of the product. Machine user has to report directly to the system manager when unusual status has been found while system is operating.**
Failure to follow this instruction may result in personal injury, economic loss or fire.
- 03. The product has to be installed, set, and combined with machine control system by the qualified system manager.**
Failure to follow this instruction may result in personal injury due to unintended operation and unstable detection.
- 04. Before using the product, check that function of the product operates as intended while machine is turned off after installation.**
Failure to follow this instruction may result in personal injury due to unintended operation and unstable detection.
- 05. Do not use the unit in the place where flammable/explosive/corrosive gas, high humidity, direct sunlight, radiant heat, vibration, impact, salinity, moisture, or steam, or dust may be present.**
Failure to follow this instruction may result in explosion or fire.
- 06. Do not disassemble or modify the unit.**
Failure to follow this instruction may result in personal injury or fire due to loss of safety function.
- 07. Do not defeat, tamper, modify, or bypass the switch and enter the door.**
Failure to follow this instruction may result in personal injury.
- 08. Check whether machine is stopped or not when the door is opened.**
Failure to follow this instruction may result in personal injury.
- 09. Check the installed status of the switch, operating status of the switch, and signs of damage, modification, tampering of the switch at the following situation and on a weekly basis.**
 - when operating the safety system at first
 - when replacing component of the system
 - when the system has not been operated for a long time
 Failure to follow this instruction may result in personal injury due to malfunction of the product and safety function.
- 10. Do not connect, repair, inspect, or replace the unit while connected to a power source.**
Failure to follow this instruction may result in fire.
- 11. Check 'Connections' before wiring.**
Failure to follow this instruction may result in fire.
- 12. Keep away from high voltage lines or power lines to prevent surge and inductive noise, and make cable as short as possible.**
In case installing power line and input signal line closely, use line filter or varistor at power line and shielded wire at input signal line.
Do not use near the equipment which generates strong magnetic force or high frequency noise.
Failure to follow this instruction may result in personal injury due to malfunction of the product and safety function.

⚠ Caution Failure to follow instructions may result in injury or product damage.

- 01. Use the unit within the rated specifications.**
Failure to follow this instruction may result in fire or product damage.
- 02. Use a dry cloth to clean the unit, and do not use water or organic solvent.**
Failure to follow this instruction may result in fire.
- 03. Make cable as short as possible, and keep the length of the cable within 100m when extent the length of the cable.**
Failure to follow this instruction may result in malfunction of the product and safety function due to surge.
- 04. When wiring two or more products in series, keep the total length of the cable within 100m.**
Failure to follow this instruction may result in malfunction of the safety function due to voltage drop.
- 05. When installing two or more product adjacently, give at least 26mm interval.**
Failure to follow this instruction may result in malfunction due to mutual interference.
- 06. Do not install the switch and actuator on the magnetic object. Use bolt and nut of stainless steel or nonmagnetic material, when installing the switch and actuator.**
Failure to follow this instruction may result in malfunction or affect sensing distance.
- 07. Do not use the switch as a guard door stopper. Install separate mechanical stopper.**
Failure to follow this instruction may result in product damage.

Cautions during Use

- Follow instructions in 'Cautions during Use'. Otherwise, it may cause unexpected accidents.
- Use the switch with the dedicated actuator and controller. Do not use the switch with another actuator or controller randomly.
The switch is cannot be used without the controller (SFC-N322).
- Power supply should be insulated and limited voltage/current or Class 2, SELV power supply device.
- When using switching mode power supply to supply the power, ground F.G. terminal and connect a condenser between 0V and F.G. terminal to remove noise.
- This unit may be used in the following environments.
 - Indoors (UL Type 1 Enclosure)
 - Altitude max. 2,000m
 - Pollution degree 3
 - Installation category II

Cautions during Installation

- Install the unit correctly with the usage environment, location, and the designated specifications.
- When installing the product, tightening the screw of M4×20mm with the tightening torque of 0.8N.m.
- Installing more than 2 non-contact door switches closely may result in malfunction due to mutual interference.
- Do not impact on the switch and excessively bend the cables.
- Install the switch to the sensing surface of the switch and the actuator be exactly parallel.

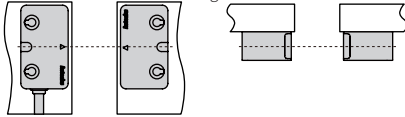

- Install the switch to the direction as below with the consideration of moving directions of the actuator.

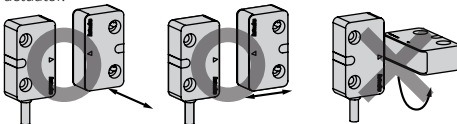

- Install the switch and actuator with a gap of minimum 1mm between them.
- Install the switch at the adjoining wall of the guard door and the actuator at guard door.

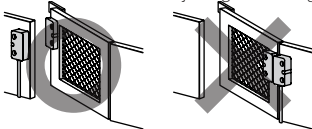

Ordering Information

This is only for reference.
For selecting the specified model, follow the Autonics website.

SFN - M - ①

- ① **Cable**
- 020: cable type (2 m)
- 050: cable type (5 m)
- W: cable connector type

Sold Separately

- Connector cable: C1D5-□, CID5-□, CID5-□-P
- Branch connector: CCD5, CYD5
- Loop connector: CND5
- Safety controller non-contat door switch unit: SFC-N322

Specifications

Model	SFN-M-□
Operating distance ⁰¹⁾	OFF→ON ≥ 5 mm
	ON→OFF ≤ 15 mm
Approval	CE, RoHS, REACH, S
Unit weight (packaged)	Cable type (2m): ≈ 100.5 g (≈ 113.8 g)
	Cable type (5m): ≈ 199.5 g (≈ 214.8 g)
	Cable connector type: ≈ 58.1 g (≈ 71.6 g)
01) It is rated at 23°C of ambient temperature, and it may be differed up to ±20% by ambient temperature.	
Power supply	24 VDC± (± 10 %)
Operating frequency	100 Hz
Power consumption ⁰¹⁾	≤ 400 mA
Auxiliary output	PNP open collector output - 24 VDC±, 10 mA
Operation indicator	ON: green, OFF: red
Life expectancy	≥ 20,000,000 times (with low load)
Insulation resistance	≥ 50 MΩ (500 VDC± megger)
Protection circuit	Surge protection circuit, output short over current protection circuit, reverse polarity protection circuit
Dielectric strength	1,500 VAC~ 50/60Hz for 1 minute
Vibration	1.0 mm amplitude at frequency of 10 to 55 Hz (for 1 min) in each X, Y, Z direction for 2 hours
Vibration (malfunction)	1.0 mm amplitude at frequency of 10 to 55 Hz (for 1 min) in each X, Y, Z direction for 10 min
Shock	300 m/s ² (≈ 30 G) in each X, Y, Z direction for 3 times
Shock (malfunction)	300m/s ² (≈ 30G) in each X, Y, Z direction in output ON/OFF status for 3 times
Ambient temperature	-10 to 55 °C, storage : -20 to 60 °C (a non freezing or condensation environment)
Ambient humidity	35 to 85 %RH, storage : 35 to 85 %RH (a non freezing or condensation environment)
Protection structure	IP67 (IEC standard)
Connection	cable type / cable connector type model
Cable	Ø 5 mm, 5-wire, cable type: 2 m/5 m, cable connector type: 0.3 m
Wire	AWG26 (0.08 mm), 28-core, core diameter: Ø 0.74 mm
connector spec.	M12 connector
material	Body/CAP: PC

01) Power to the load is not included.

Charateristic level / Safety category (with SFC-N322)	IEC 61508 SIL 3 IEC 62061 SIL CL 3 ISO 13849-1 PLc Cat.4 - HFT = 1 - Diagnostic Coverage : 99 % (high) - MTTFd = 100 year (high) - Mission time = 20 year - PFH = 3.88E-09
--	---

Safety status in case of error: the switch does not have an internal error recognition function, so it cannot maintain a safety status in the event of error.
Error recognition is processed in the connected controller (SFC-N322).

Operation Distance

- Operating distance represents the distance between the sensing surface of switch and that of actuator.
- Operating distance can be differed according to the moving direction of actuator from the switch. (at ambient temperature of 23 °C)
- The operating distance may be affected by metal or magnetic substances which is placed closely to the switch.

Operation status	Moving direction	Operating distance
OFF → ON	Front - Back	≥ 5 mm
	Top - Bottom	≥ 2 mm
	Left - Right	≥ 5 mm
ON → OFF	Front - Back	≤ 15 mm
	Top - Bottom	≥ 6 mm
	Left - Right	≤ 15 mm

Connections

Signal	Function	Pin	Color	Controller (SFC-N322)
Power input	VCC	1	brown	D3
	GND	3	blue	D4
Signal input	IN	2	white	D1
Signal output	OUT	4	black	D2
Auxiliary output	AUX	5	yellow	-

• M 12 connector pin arrangement

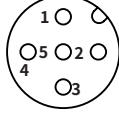

Connection Examples

■ Cable type

Wiring a single switch

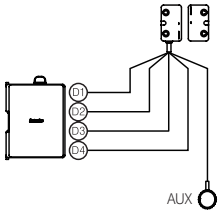

Wiring multiple switches

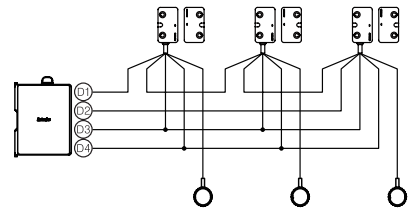

■ Cable connector type

Wiring a single switch

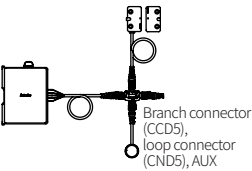

Branch connector (CCD5),
loop connector (CND5), AUX

Wiring multiple switches

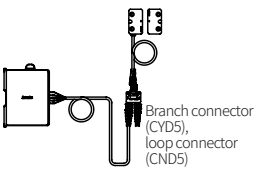
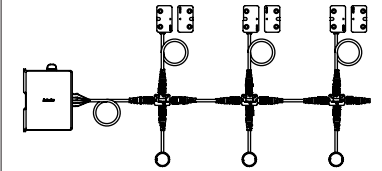

Branch connector (CYD5),
loop connector (CND5)

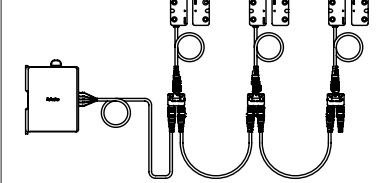

Maximum 30 unit of switches can be connected to a controller (SFC-N322).

Dimensions

• Unit: mm, For the detailed drawings, follow the Autonics website.

■ Cable type

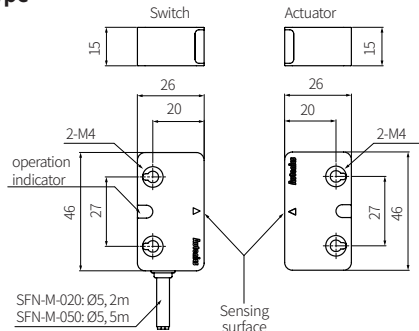

■ Cable connector type

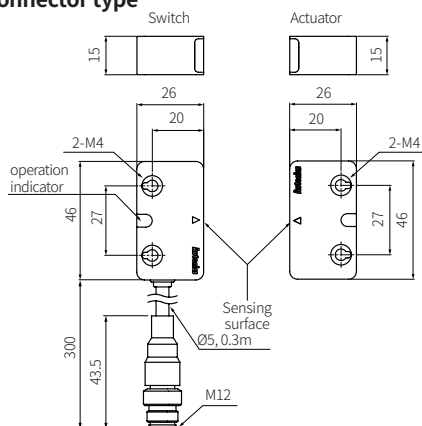

Branch Connector (sold separately)

• Unit: mm, For the detailed drawings, follow the Autonics website.

■ CCD5

Dimension

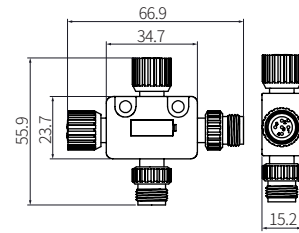

Connection diagram

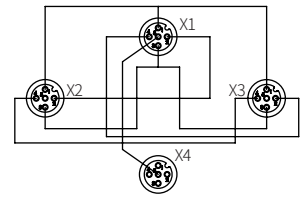

■ CYD5

Dimension

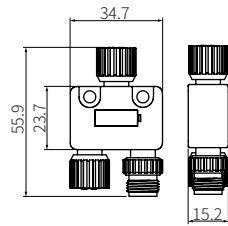

Connection diagram

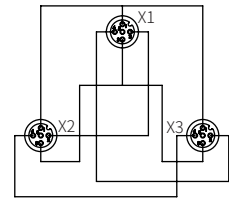

Loop Connector (sold separately)

• Unit: mm, For the detailed drawings, follow the Autonics website.

■ CND5

Dimension

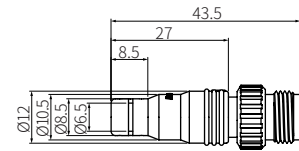

Connection diagram



Connector Cable (sold separately)

• Unit: mm, For the detailed drawings, follow the Autonics website.
• □ in model stands for the cable length.

■ C1D5-□

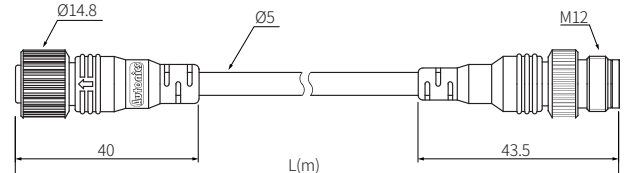

■ CID5-□

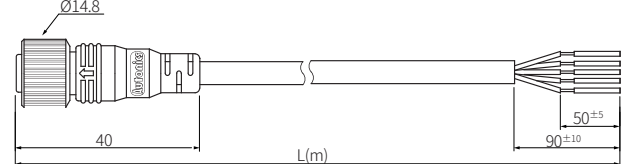

■ CID5-□-P

